

CARATTERISTICHE • SPECIFICATIONS • CARACTERISTIQUES
ANGABEN • CARACTERISTICAS • ХАРАКТЕРИСТИКИ



ROUND
150



~ 340 l

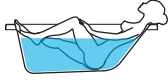

~ 275 l



220-240 V
50/60 Hz
3,5 A - 0,7 kW



166x166x86 cm
~ 105 kg



~ 60 kg

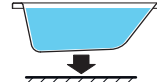

~ 227 kg/m²

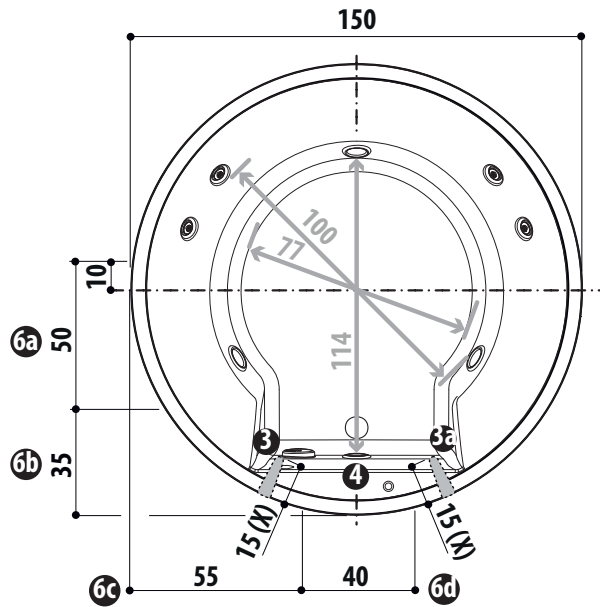
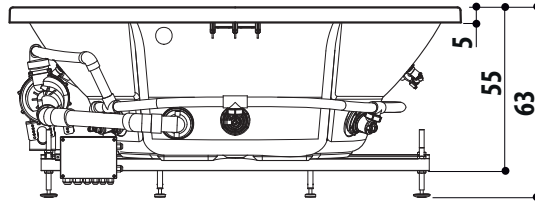

cm

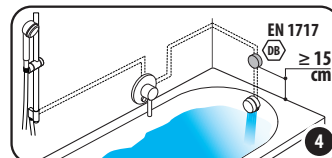
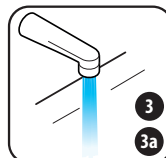
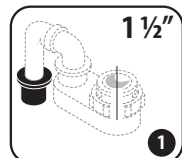
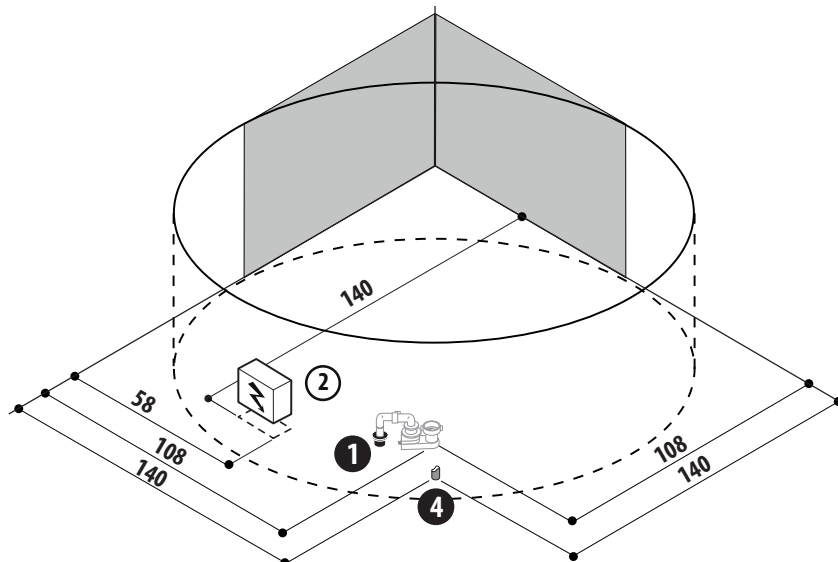

ALLEGARE IL TESTO DI PREINSTALLAZIONE - ADD TO THIS SHEET THE PREINSTALLATION INSTRUCTIONS - FICHE À ASSOCIER AU TEXT DE PRE-INSTALLATION - DIESES DATENBLATT MUSS VOM VORINSTALLATIONS TEXT - FICHA A UNIRSE AL TEXTO DE PREINSTALACIÓN - ПРИЛОЖИТЬ К ПРЕДВАРИТЕЛЬНОЙ ТЕКСТАМ