

**CARATTERISTICHE • SPECIFICATIONS • CARACTERISTIQUES
ANGABEN • CARACTERISTICAS • ХАРАКТЕРИСТИКИ**



220-240 V - 50/60 Hz
6/12 (*) A
1,2 / 2,5 (*) kW



172x116x74 cm
~ 90 kg



**AQUASOUL
OFFSET
150X100**

(*) con sistema di mantenimento della temperatura dell'acqua • with water temperature control system • avec système de maintien de la température de l'eau
mit system zur Erhaltung der Wassertemperatur • con sistema de mantenimiento de la temperatura del agua • с система поддержания температуры воды

- I disegni riportati non sono in scala
- The show drawings are not scaled
- Les dessins reportés ne sont pas à l'échelle
- Die Zeichnungen sind nicht im Maßstab
- Los dibujos representados no son en escala
- Рисунки приведены не в масштабе

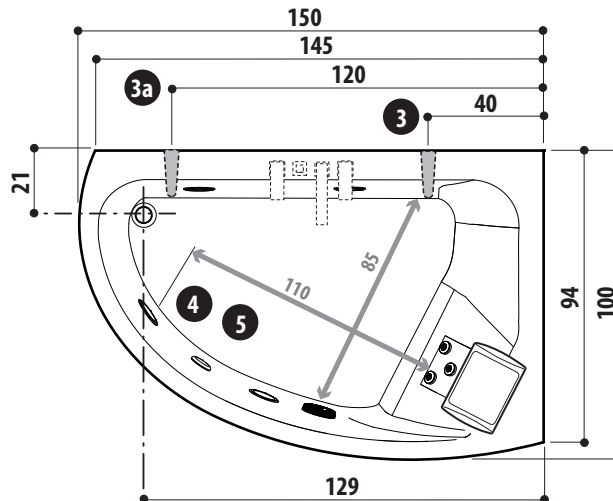
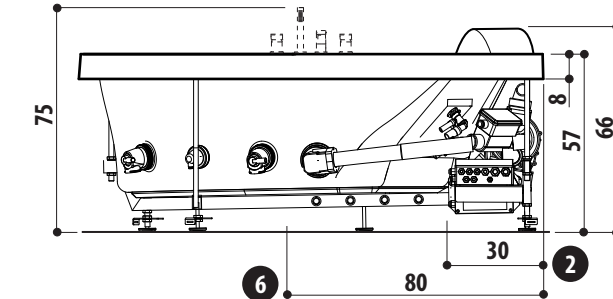

DX

cm

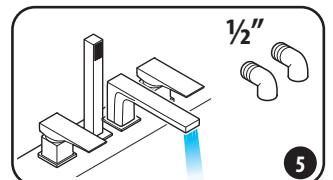
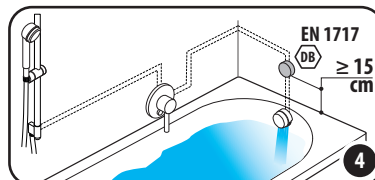
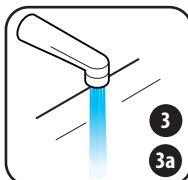
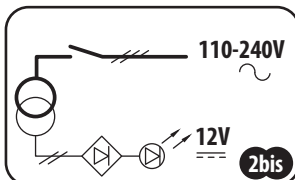
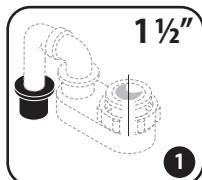
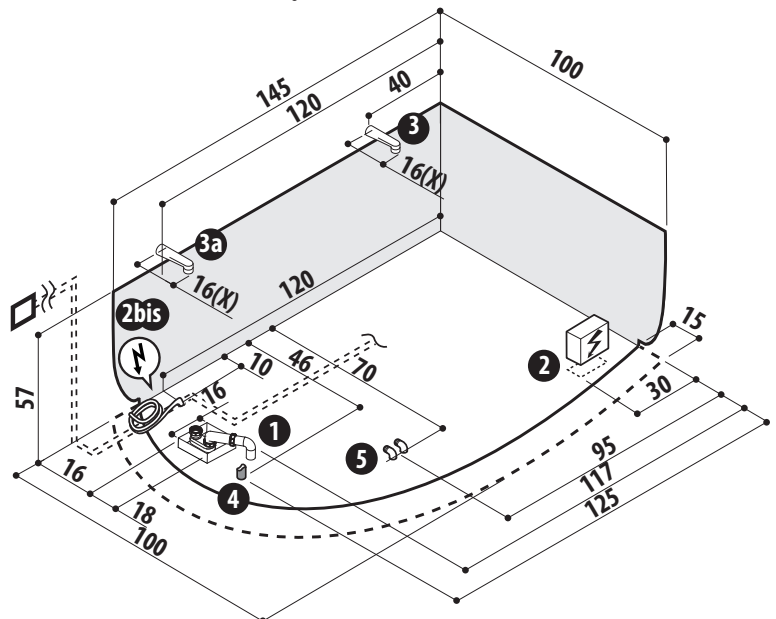
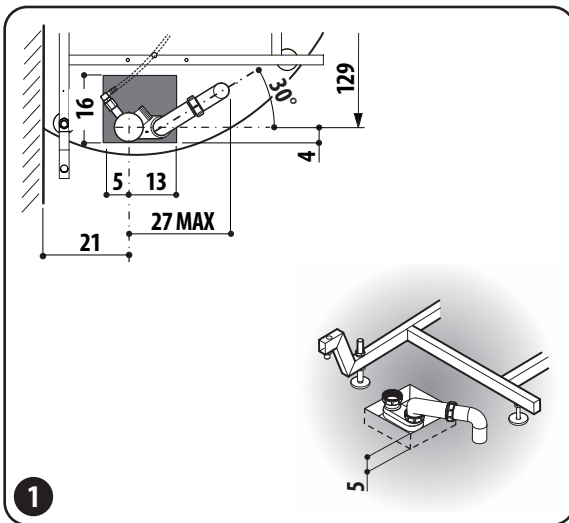

ALLEGARE IL TESTO DI PREINSTALLAZIONE - ADD TO THIS SHEET THE PREINSTALLATION INSTRUCTIONS - FICHE À ASSOCIER AU TEXTE DE PRE-INSTALLATION - DIESES DATENBLATT MUSS VOM VORINSTALLATIONS TEXT - FICHA A UNIRSE AL TEXTO DE PREINSTALACIÓN
ПРИЛОЖИТЬ К ПРЕВАРИТЕЛЬНОЙ ТЕКСТАМ